

CHT5 / CHT51

Original Operating Instructions



CHT5-2 / CHT51-2

1 Dimensional drawing

CHT5

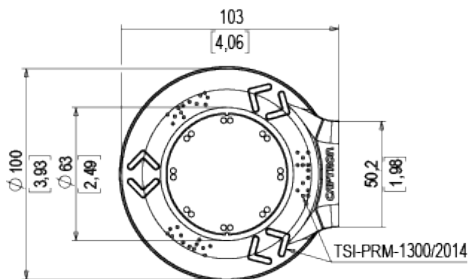
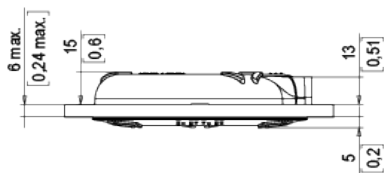
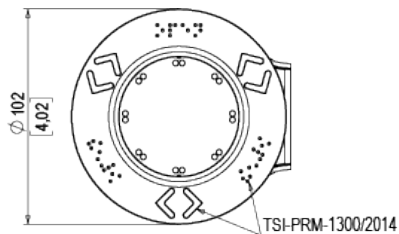

CHT51

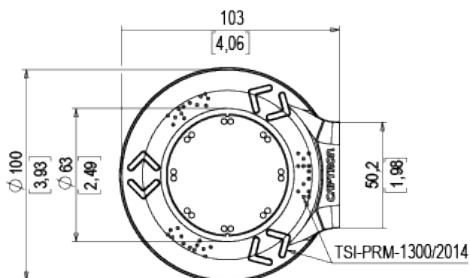
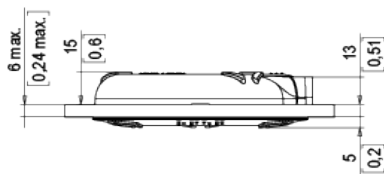
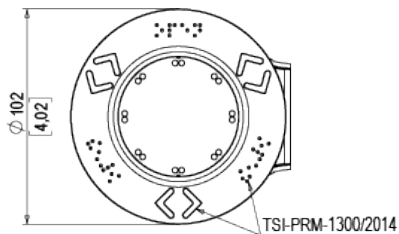

2 Technical specifications

CHT5 and CHT51 PNP-NO, 4-pin 24 V

Operating voltage	DC 24 V (16.8 ...32 V)
Load current	Max. 200 mA
Output pulse	~ 1 s (depending on the actuation duration)
Reverse polarity protection	Protection of all lines
Short circuit protection	Protected against short circuit and overload
Voltage drop	Max. 3 V at 400 mA
Power consumption at 24 V	Max. 30 mA
Operating temperature	-30°C (-22°F)....+80°C (176°F)
Degree of protection IP	Front IP69K
Type of actuation	Capacitive
Actuation force	No actuation force required

CHT5 and CHT51 PNP-NO, 5-pin 24 V

Operating voltage	DC 24 V (16.8 ...32 V)
Load current	Max. 200 mA
Output pulse	~ 1 s (depending on the actuation duration)
Reverse polarity protection	Protection of all lines
Short circuit protection	Protected against short circuit and overload
Voltage drop	Max. 3 V at 200 mA
Power consumption at 24 V	Max. 35 mA
Operating temperature	-30°C (-22°F)....+70°C (158°F)
Degree of protection IP	Front IP69K
Type of actuation	Capacitive
Actuation force	No actuation force required

CHT5 PNP-NO, 4-pin 110 V

Operating voltage	DC 110 V (77 ...137.5 V)
Load current	Max. 15 mA
Output pulse	~ 1 s (depending on the actuation duration)
Reverse polarity protection	Protection of all lines
Short circuit protection	Protected against short circuit and overload
Voltage drop	Max. 3 V at 10 mA
Power consumption at 110 V	Max. 15 mA
Operating temperature	-25°C (-13°F)....+70°C (158°F)
Degree of protection IP	Front IP69K
Type of actuation	Capacitive
Actuation force	No actuation force required

CHT5 PNP-NO, 4-pin 12 V

Operating voltage	DC 12 V (8.4 ...15.6 V)
Load current	Max. 200 mA
Output pulse	~ 1 s (depending on the actuation duration)
Reverse polarity protection	Protection of all lines
Short circuit protection	Protected against short circuit and overload
Voltage drop	Max. 3 V at 200 mA
Power consumption at 12 V	Max. 20 mA
Operating temperature	-30°C (-22°F)....+70°C (158°F)
Degree of protection IP	Front IP69K
Type of actuation	Capacitive
Actuation force	No actuation force required

3 Connection plan

PNP-NO, 4-pin

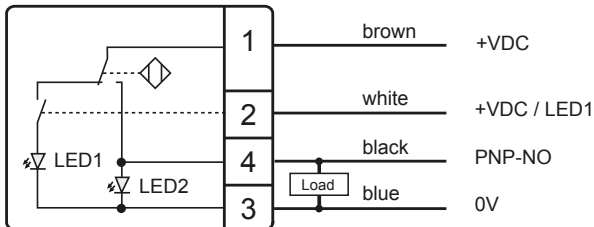

PNP-NO, 5-pin

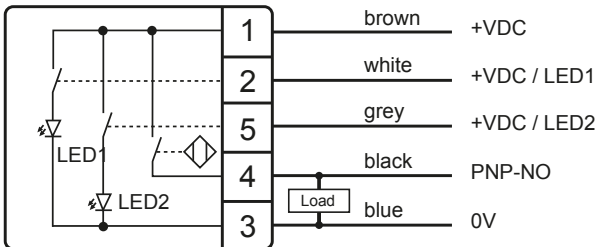

4 Connection options

Connector

CHT5-26#.... CHT51-26#....

Connector JST 2.54, 4-pin

CHT5-2M#.... CHT51-2M#....

Connector JST 2.0, 5-pin

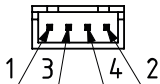

Cable

CHT5-20#....

Cable, 4-pin

2 m cable with wire end ferrules

Wire end ferrules with plastic collars DIN 46228

Wire cross-section strands 0.25 mm²

Foreword

This manual has been written for technicians/installers and operators and should be kept for future reference. Read these operating instructions carefully and make sure that you have fully understood the contents before installing or working with the CHT5 or CHT51.

5 Safety



WARNING

Improper work on electrical systems!

Electric shock can result in death or life-threatening injuries.

- ▶ Before working on electrical systems, disconnect them from their voltage supply and secure them against being switched on again.
- ▶ Work on electrical installations should only be carried out by qualified personnel.
- ▶ Wear appropriate personal protective equipment (PPE).

5.1 Intended use

The SENSORswitch is designed for use in accordance with the technical specifications. The values can be found in the “Technical specifications” chapter and the “Product description”.

5.2 Reasonably foreseeable misuse

A use other than that specified under chapter [Intended use](#) or extending beyond this is deemed to be improper.

The SENSORswitch is not suitable for:

- use in potentially explosive atmospheres.
- use as a safety component as per directive 2006/42/EC

6 General description

The supplied SENSORswitch can have options that differ from those shown in this manual. This does not affect the function. The SENSORswitch is equipped with different color LEDs to indicate operating conditions. The LEDs are actuated differently depending on the pin configuration.

A	Colored position ring
B	Pane of glass CHT5, single pane CHT51, double pane
C	Mounting flange BF-95-2
D	SENSORswitch
E	Colored cover ring AR5-2X_

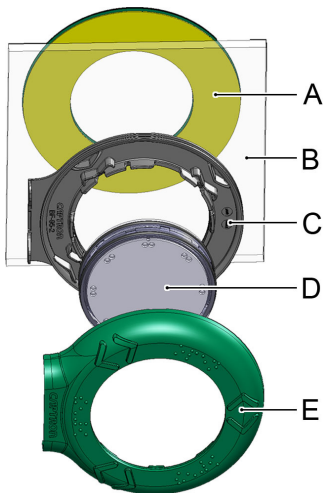

7 Assembly

7.1 Assembly, inside

7.1.1 Cleaning the surface

Requirements: The surface is level and sound.

For optimal gluing results, the surface must be cleaned thoroughly at the position where the button will be located.

- ▶ Clean the surface with cleaning cloth A.
- ▶ Dry the surface with a lint-free cloth.
- ▶ Clean the surface with cleaning cloth B.
- ▶ Dry the surface with a lint-free cloth.



7.1.2 Assembling the mounting flange

NOTICE

Soiled bond areas prevent proper assembly!

- ▶ Protect the bond area from soiling.
- ▶ Do not touch the bond area.
- ▶ If the bond area has been touched or soiled, use a new mounting flange.

- ▶ Insert the supplied O-ring into the groove (D) on the mounting flange.
- ▶ Remove the protective film from the mounting flange (C).
- ▶ Align the mounting flange (C) to the hole (B), place it on the profile of the glass frame (A) and press on firmly.

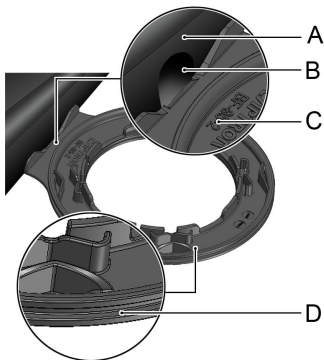

7.1.3 Assembling the SENSORswitch

- ▶ Connect the SENSORswitch electrically according to the connection plan.
- ▶ Align the sensor element as shown in the figure, paying attention to the direction of the symbol. The recesses on the plug (A) must be facing the pane of glass.
- ▶ Press the sensor element into the mounting flange and check whether the sensor element is flat on the pane of glass.
- ▶ Lay the fastening cable between the ridges (B).

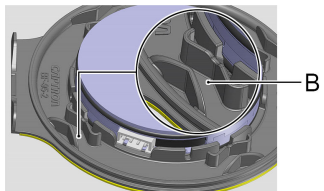
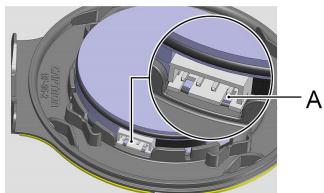

7.1.4 Mounting the colored cover ring

- ▶ Place the cover ring and press close to the button surface. The cover ring must be flush with the entire button surface.

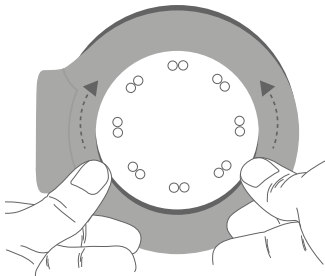

7.2 Assembly, outside

7.2.1 Cleaning the surface

Requirements: The surface is level and sound.

For optimal gluing results, the surface must be cleaned thoroughly at the position where the button will be located.

- ▶ Clean the surface with cleaning cloth A.
- ▶ Dry the surface with a lint-free cloth.
- ▶ Clean the surface with cleaning cloth B.
- ▶ Dry the surface with a lint-free cloth.



7.2.2 Mounting the colored position ring

NOTICE

Soiled bond areas prevent proper assembly!

- ▶ Protect the bond area from soiling.
- ▶ Do not touch the bond area.
- ▶ If the bond area has been touched or soiled, use a new colored position ring.
- ▶ Remove the protective film from the colored position ring.
- ▶ Align the colored position ring centered to the SENSORswitch, paying attention to the position of the Braille characters or relief.
- ▶ Press down firmly on the entire surface of the colored position ring.

8 Maintenance

8.1 Maintenance operations

Carry out the following maintenance operations at the specified intervals.

Maintenance operation	as needed	annually
Clean the switch surface	X	

NOTICE

Solvents contained in cleaning agents can attack the plastic of the button!

- ▶ Clean the surface of the button with a neutral cleaning agent or a damp microfiber cloth.

9 Disassembly

9.1 Disassembling the SENSORswitch

- ▶ Disconnect the system from its voltage supply and secure it against being switched on again.
- ▶ Insert the flat head screwdriver into the groove (A) on the colored cover ring, lift the cover ring with the screwdriver via lever action.
- ▶ Disconnect the electrical connection from the SENSORswitch.
- ▶ Remove the SENSORswitch from the mounting flange using a flat head screwdriver.

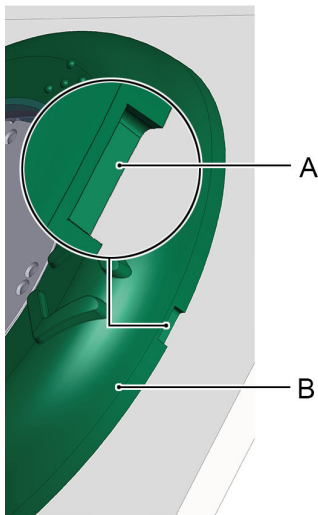

9.2 Disassembling the mounting flange and colored position ring

NOTICE

If the temperature of the hot air fan is set too high, this may damage the surrounding labels and pane of glass!

- ▶ Do not set the temperature too high.

- ▶ Evenly heat the mounting flange or colored position ring as well as the pane of glass using a hot air fan.
- ▶ Remove the mounting flange or colored position ring from the pane using a glass scraper.
- ▶ Remove all remaining glue residues from the pane using label remover.

10 Disposal

Electrical and electronic components of various types must be recycled according to their type.

11 Options

11.1 Color variations

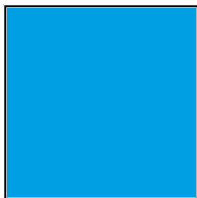

RAL5015

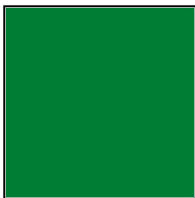

RAL6024

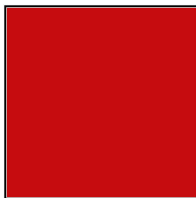

RAL3020

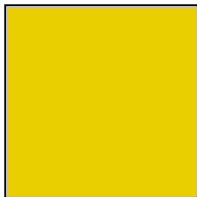

RAL1023

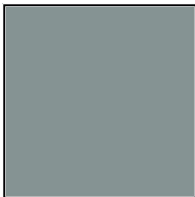

RAL7042

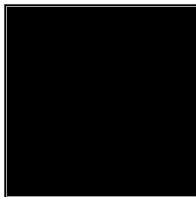

RAL9017

11.2 Angle variations colored cover ring

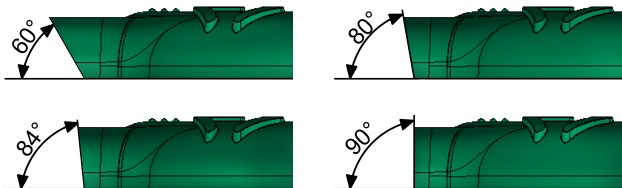

11.3 Raised pictograms and Braille characters

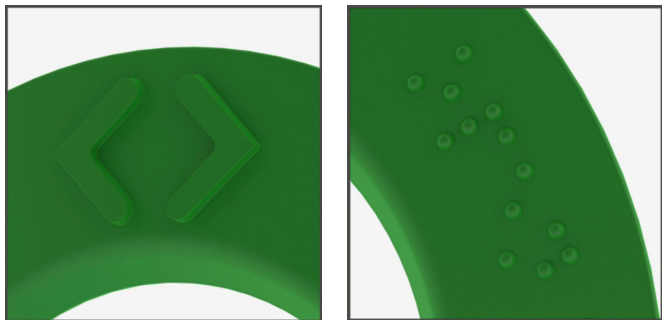

12 Imprint

The operating instructions have been authored and published by
CAPTRON Electronic GmbH – Johann-G.-Gutenberg Straße 7 – 82140 Olching
– Germany
Copyright 2018